



Innovative Multibeam Technology

Manufactured by



MORE TECHNOLOGY. MORE RESULTS.

Commercial fishing operators worldwide are benefiting from WASSP Multibeam Sonar.

SEA MORE - CATCH MORE - DISCOVER MORE - MAP MORE



Innovative Multibeam Technology

Future-Proofing your Commercial Fishing Operation.

Improve your fishing business with WASSP multibeam technology. WASSP multibeam sonar features multiple key functions designed to optimise fishing operations by enabling you to reduce gear damage, fuel costs and sea time, while importantly, increasing catch rates.

With WASSP multibeam technology your understanding of the marine environment will be greatly improved, enabling you to become more target specific, reducing by-catch and the impact on the environment. WASSP is the technology for the future of commercial fishing.

SEA MORE

WASSP multibeam technology delivers 120° high resolution coverage and quickly locates and profiles fish shoals – both pelagic and ground fish.

WASSP will profile fish shoals over reef and ground structure, wrecks and changes in seafloor hardness, enabling fishermen to target specific shoals of fish or specific ground habitat for lobster, crayfish, prawns, and langoustine.

DISCOVER MORE

WASSP multibeam technology generates extremely detailed bathymetric profiles allowing fishermen to be very target specific.

This dramatically reduces gear damage while increasing catch rates. A 'win-win' outcome. Seafloor hardness can be displayed in 2D and 3D; in full colour or black and white; allowing fishing operators to discover more new fishing grounds and optimise their fishing activity.

MAP MORE

WASSP multibeam technology can generate over 700 depth points per second. Each point is stabilised, tide corrected, and seafloor hardness characterised.

This allows fishermen to very quickly build high resolution bathymetric profiles of the marine environment they operate in.

Importantly, WASSP also profiles all fish and water column targets building the true picture: – hardness + profile + fish targets into a real-time 3D display.

WASSP delivers unparalleled 120° high resolution coverage.

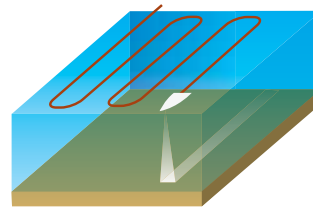

Conventional (10°) single beam sonar.

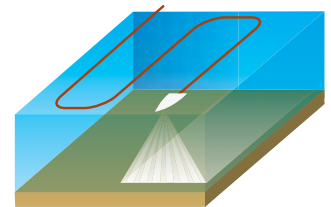

WASSP Multibeam sonar (120°) high resolution coverage.

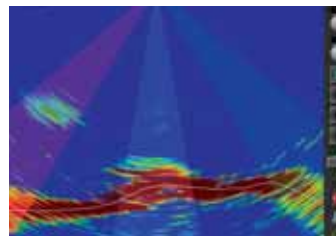

Sonar & mid-water fish.

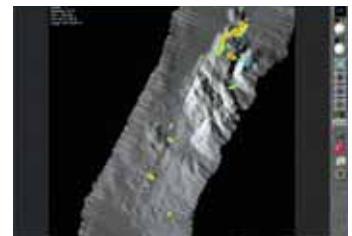

Fish marks over reef structure.

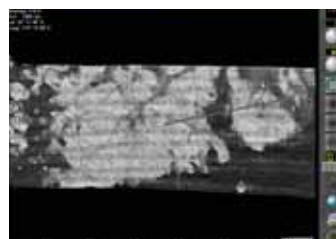

Black & white hardness view.

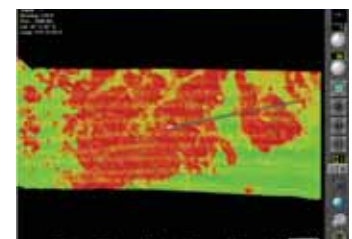

Full colour hardness.

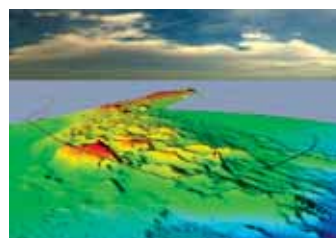

Detailed bathymetric profile 3D.

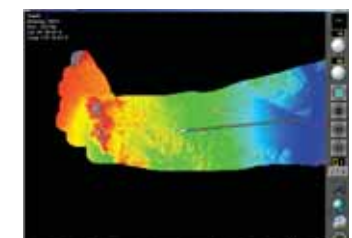

Detailed bathymetric profile 2D.

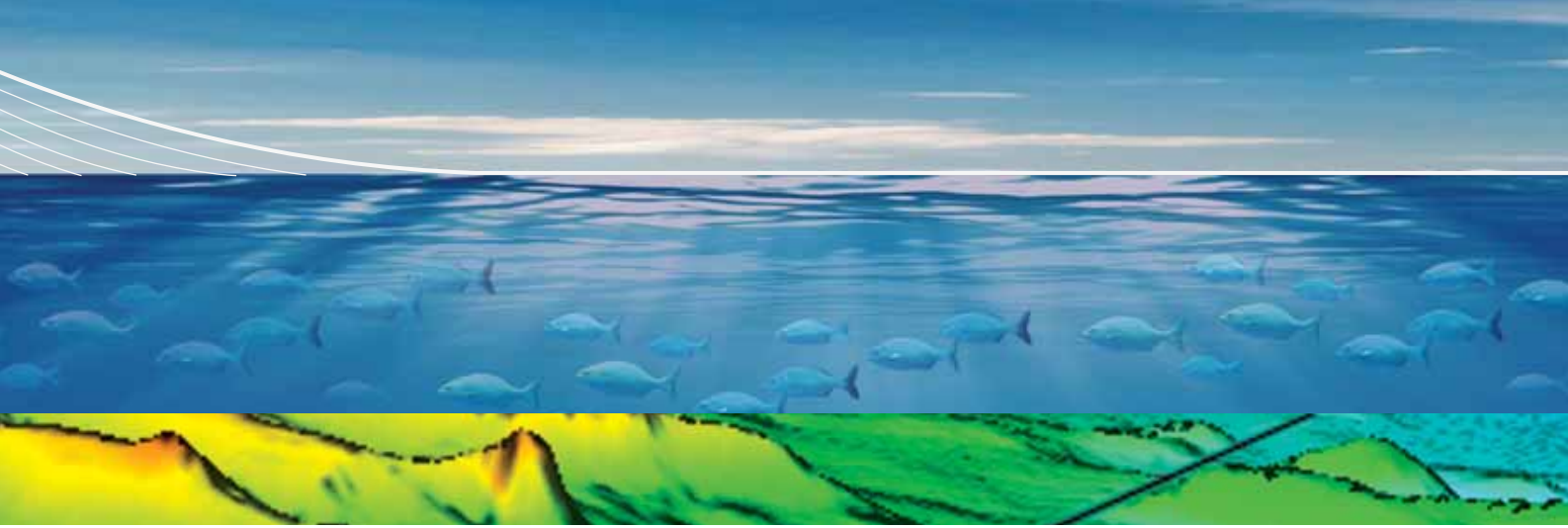

Innovative Multibeam Technology

NAVIGATOR

More information when you need it.

MORE DEPTH

WASSP multibeam sonars are packed with features to enable you to better understand the marine environment. There are two frequency options available, 160kHz or 80kHz, depending upon the depth performance required. WASSP can profile from 1metre to over 500metres which meets most fishing applications-talk to your WASSP agent about the frequency that best suits your fishing needs.

MORE EASE

WASSP customers – from fishermen and marine scientists to surveyors- report how easy WASSP is to use. A computer-mouse controls all functions and a user-friendly split-screen Windows System allows you to optimise the displays to suit your particular fishing requirements. WASSP hardware is designed and manufactured to ISO9001-2008 standards.

MORE OPTIONS.

WASSP Navigator now gives you the ability to overlay bathymetric data, fish shoal information and seafloor hardness information with a Navionics Gold® raster chart database, so you can view, scroll, save and better utilise the valuable information generated by WASSP.

Flexibility is key and WASSP enables you to export your bathymetric profiles and fish information to world renowned plotting systems such as Olex and Sodena Turbo Tactic.

What a commercial fisherman has to say....

“WASSP is really marvellous- we have increased our daily catches about 20% while the other trawlers have real difficulty to reach their targeted catch volume at the moment. Also I identify the shoal species more according to the multibeam view and I catch more ‘pure’ species...”

Alain Rico “Septimanie 11”,
French Fisherman, South of France

SHARE MORE WITH WASSP NAVIGATOR

WASSP Navigator will enable you to build and save very detailed bathymetric profiles, to record and save fish shoal information and to share this information with other WASSP users or vessels in the fleet.

Navigator is a management tool to enable you to highlight, profile, view in any direction – 2D or 3D- save and print information you collect about the marine environment. It’s fast, accurate and very easy to use.

3D view of reef plus fish in the water column.

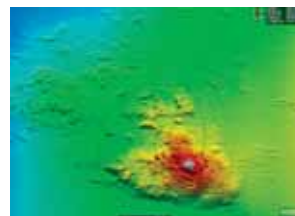

1946
ESTABLISHED

2010



Innovative Multibeam Technology

WASSP Multibeam Sonar Specifications

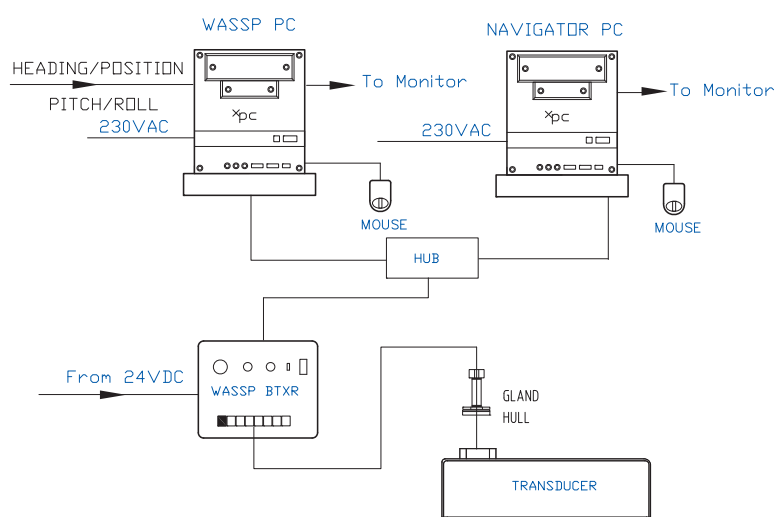

160kHz Transducer

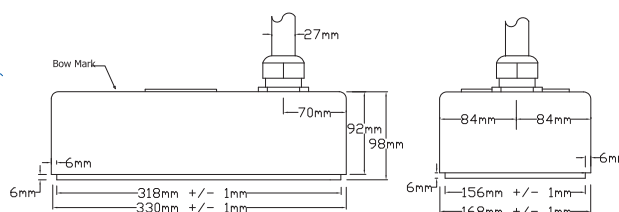

BTxR Dimensions

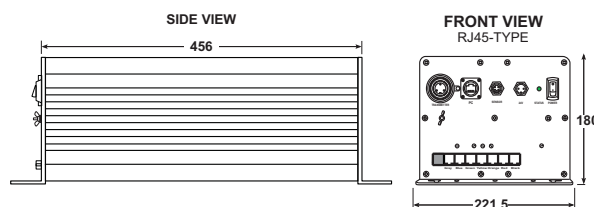

Frequency	160kHz	80 kHz
Sonar Type	Multibeam	Multibeam
Power	40W to 1.2kW	150w to 1.5kw
Transducer Dimensions	330mm(L) x 168mm(W) x 98mm(H)	533mm(L) x 340mm(W) x 98mm(H)
Transducer Weight	15 kg with standard 10m cable	39 kg with 20m cable
Transmit Beam Width (ar thwartships * fore-aft)	120° * 3.5°	120° * 3.5°
Depth Range	1m – 200m	10m – 500m
Beam Forming / Spacing	Digital – 112 equiangular beams from a 120° swath.	Digital – 112 equiangular beams from a 120° swath.
Attitude Correction (Accuracy based on sensor used)	Pitch, Roll, Heave, heading	Pitch, Roll, Heave, heading

*Prices and specifications subject to change without notice.

65 Gaunt Street, Westhaven, Auckland, New Zealand
PO Box 5849, Auckland 1141

Phone: +64 9 373 5595
Fax: +64 9 379 5655
www.enl.co.nz